

LOW NOISE AMPLIFIER

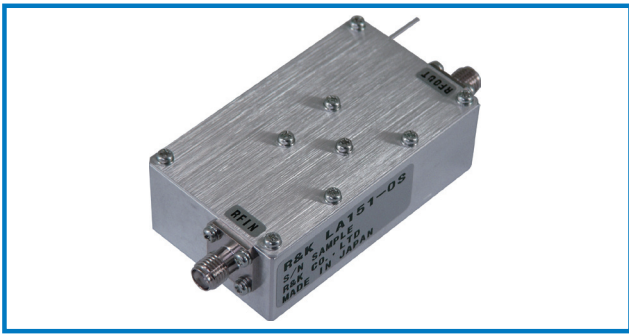

R&K-LA151-0S



OUTLINE DRAWING

※IN MILLIMETERS

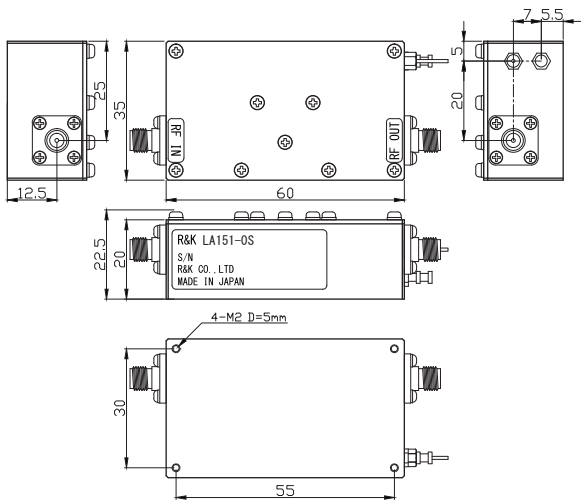

- Noise Figure : 2.0dB (typ.)
-20°C to +60°C : 3.0dB (max.)
- Frequency Range : 1GHz~6.5GHz
- Output Power : +13dBm (min.) @4GHz
- Small Signal Gain : +44dB (typ.) @4GHz
- RoHS Compliance

SPECIFICATIONS @ +25°C

- Noise Figure @ +25°C : 2.0dB (typ.)
-20°C to +60°C : 3.0dB (max.)
- Frequency Range : 1GHz ~ 6.5GHz
- Small Signal Gain : +44dB (typ.) @4GHz
+42dB (min.)
- Gain Flatness : ±2.5dB (max.)
- Output Power @1dB Comp. : +13dBm (min.) @4GHz
- Output I.C.P. : +25dBm (typ.) @4GHz
- Impedance : 50Ω
- Input VSWR : 2.0:1 (typ.)
- Output VSWR : 2.0:1 (typ.)
- DC Supply Input : +12V ±1V
: 150mA (max.)
- Maximum RF Input Power : -24dBm
- Operating Temperature : -20°C to +60°C
- Storage Temperature : -20°C to +80°C
- RF Connectors (Standard) : SMA-FEMALE
- RF Connectors (Option) : N-FEMALE
- Power Terminal : Solder
- Weight (Standard) : 100g (typ.)

HOW TO ORDER

Model Name
 R&K-LA151-0S

S = SMA - FEMALE
 N = N - FEMALE

TYPICAL PERFORMANCE

Small Signal Gain & Gain Flatness

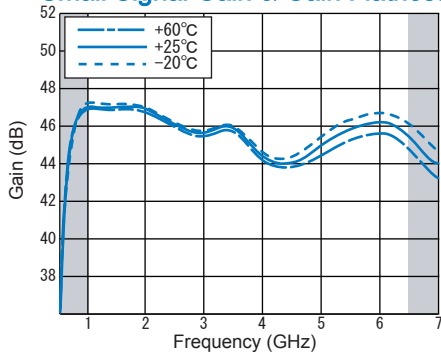

Input / Output VSWR

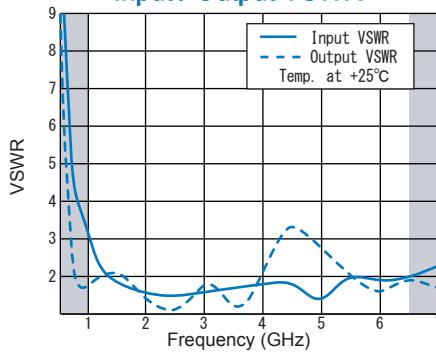

SCHEMATIC

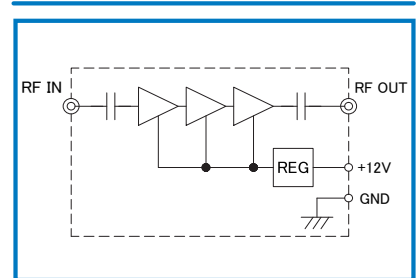

Output Power 1dB Gain Comp.

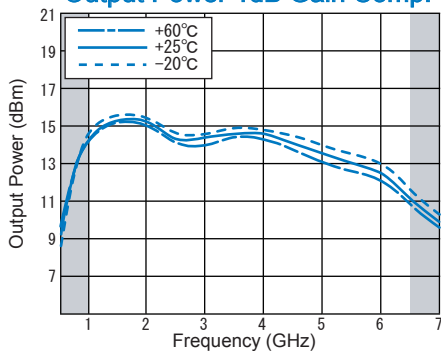

Output Power 3dB Gain Comp.

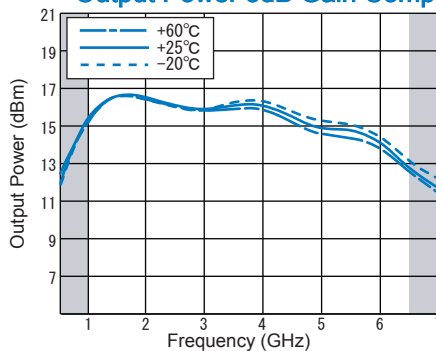

Noise Figure

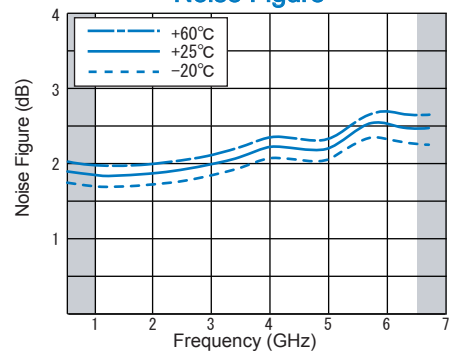

R&K reserves the right to make changes in the specifications of or discontinue products at any time without notice. R&K products shall not be used for or in connection with equipment that requires an extremely high level of reliability and safety such as aerospace uses or medical life support equipment. Further, R&K cannot export products to any country for use in military or defense applications.

R&K Company Limited

721-1 Maeda, Fuji-City, Shizuoka-Pref. 416-8577 Japan
 Tel: +81-545-31-2600 E-mail: info@rkco.jp
 Fax: +81-545-31-1600 URL: http://rk-microwave.com