

RF POWER AMPLIFIER

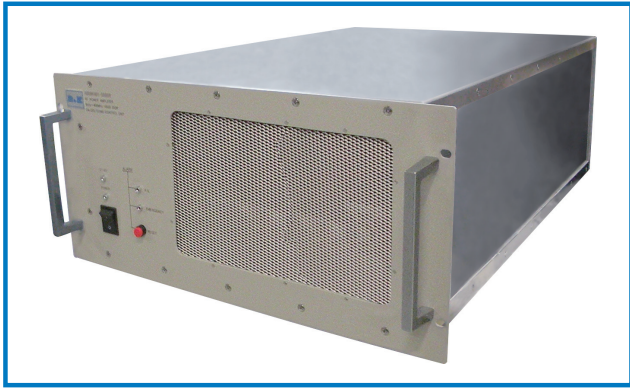

R&K-GA252M602-4747R



OUTLINE DRAWING

※ IN MILLIMETERS

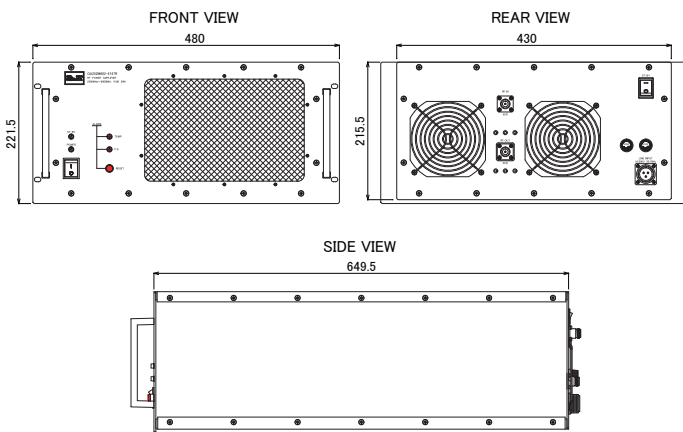

- Ultra Wide Band Power Amplifier
- Broadband Frequency: 2500MHz ~ 6000MHz
- Output Power (CW) : 50W (min.) @1dB Comp.
- With Output Circulator

APPLICATION

- EMC (Electromagnetic Compatibility)
- Accelerator Application
- Telecommunication Test and Measurement Application
- Etc...

SPECIFICATIONS @ +25°C

Frequency Range	: 2500MHz ~ 6000MHz
Small Signal Gain	: +47.0dB (min.)
Gain Flatness	: ±3.0dB (max.)
Output Power (CW)	: 50W (min.) @1dB Comp.
Harmonics	: -20.0dBc (max.) @Po=50W
Spurious	: -70.0dBc (max.) @Po=50W
Impedance	: 50Ω
Input VSWR	: 2.0 (max.)
Output VSWR	: 2.0 (max.)
Maximum RF Input Power	: +3.0dBm
AC Supply Input	: AC200V ± 10% / 1φ, 50/60Hz, 1.4kVA
Operating Temperature	: 0°C to +40°C
Storage Temperature	: -15°C to +65°C
Connectors	: RF-IN N-FEMALE @REAR PANEL RF-OUT N-FEMALE @REAR PANEL
Size	: (W)480mm × (D)649.5mm × (H)221.5mm (EIA:5U)
Weight	: 30.0kg (typ.) Δ1
Cooling	: Forced Air Cooling
Protection Circuits	: Over Temperature Protection Power Supply Voltage Protection
Other Function	: With Output Circulator

TYPICAL PERFORMANCE (Temp @+25°C)

Small Signal Gain & Gain Flatness

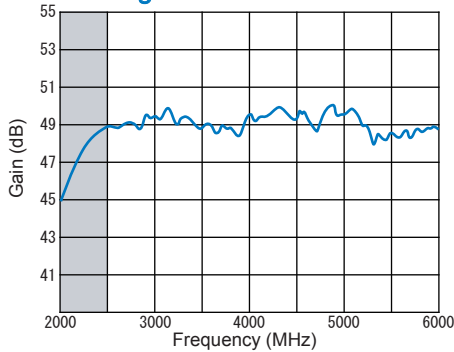

Input / Output VSWR

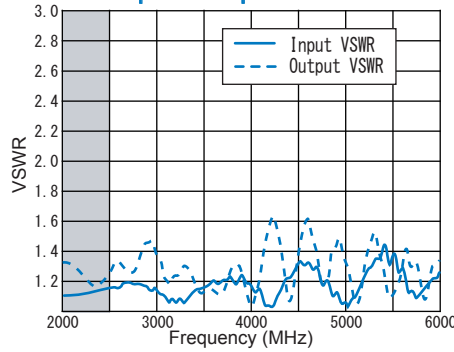

Output Power Linearity

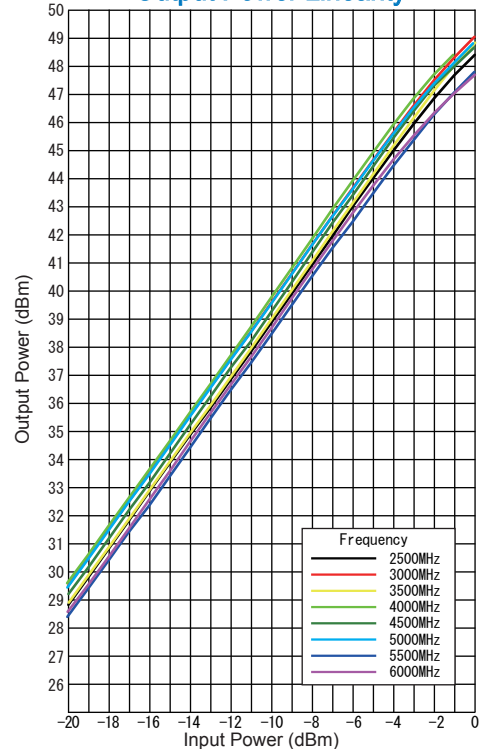

Output Power 1dB Gain Comp.

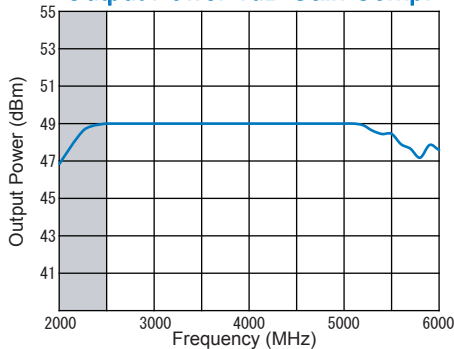

Output Harmonics

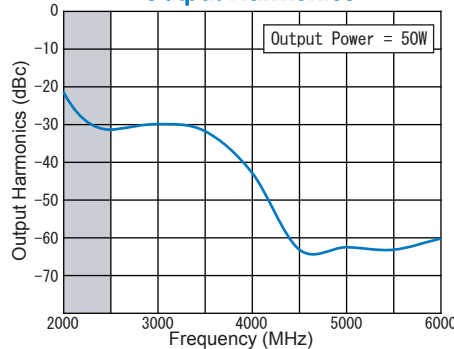

* CHANGE Δ1 27/Apr./2018

R&K reserves the right to make changes in the specifications of or discontinue products at any time without notice. R&K products shall not be used for or in connection with equipment that requires an extremely high level of reliability and safety such as aerospace uses or medical life support equipment. Further, The export of R&K products from Japan may be subject to an export license by the government of Japan, based on Japan's "Foreign Exchange and Foreign Trade Law".

R&K Company Limited

721-1 Maeda, Fuji-City, Shizuoka-Pref. 416-8577 Japan
 Tel : +81-545-31-2600 E-mail : info@rkco.jp
 Fax : +81-545-31-1600 URL : http://rk-microwave.com