

DOUBLE BALANCED MIXER

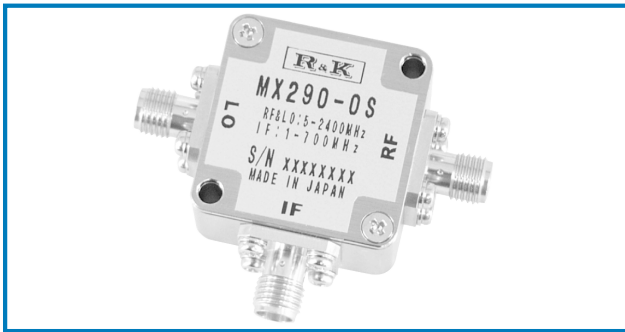

R&K-MX290-0S



OUTLINE DRAWING

※IN MILLIMETERS

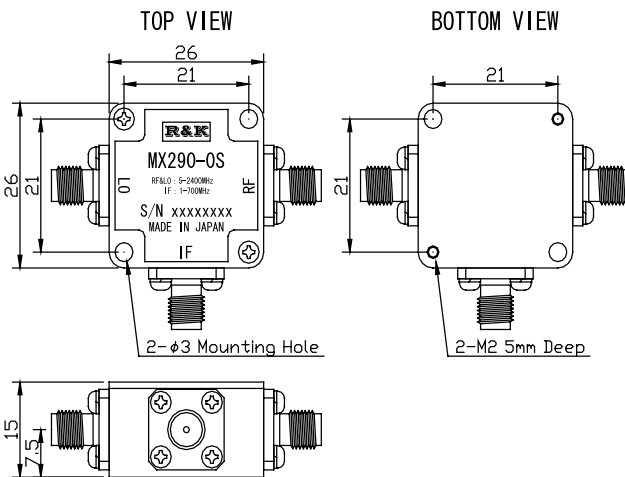

- LO&RF Frequency : 5 ~ 2400MHz
- IF Frequency : 1 ~ 700MHz
- Lo Drive Level : +7dBm
- Low Cost
- RoHS Compliance

SPECIFICATIONS

Frequency Range [LO&RF] : 5 - 2400MHz
 [IF] : 1 - 700MHz
 Conversion Loss Max. (LO Drive Level +7dBm)

	5 - 50MHz	50 - 1200MHz	1200 - 2400MHz
Typ.	7.0dB	7.0dB	8.0dB
Max.	10.0dB	9.0dB	10.0dB

Isolation (min.)

	5 - 50MHz	50 - 1200MHz	1200 - 2400MHz
LO - RF	45dB	25dB	18dB
LO - IF	40dB	18dB	15dB
RF - IF	10dB	10dB	8dB

- Input IP3 @Center Band : +10dBm (typ.)
- Input 1dB Comp. Point : + 1dBm (typ.)
- Impedance (All Ports) : 50Ω
- Maximum RF Input Power : 50mW
- Maximum Peak IF Current : 50mA
- Operating Temperature : -40°C to + 85°C
- Storage Temperature : -40°C to +100°C
- Connectors (Standard) : SMA-Female
- Connectors (Option) : N-Female
- Weight (SMA Connector) : 30g (typ.)

HOW TO ORDER

Model Name R&K-MX290-0S
 S = SMA - FEMALE
 N = N - FEMALE

TYPICAL PERFORMANCE (Temp @+25°C)

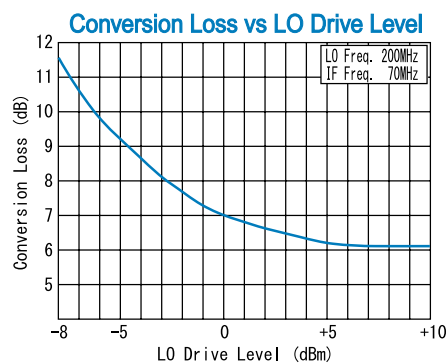
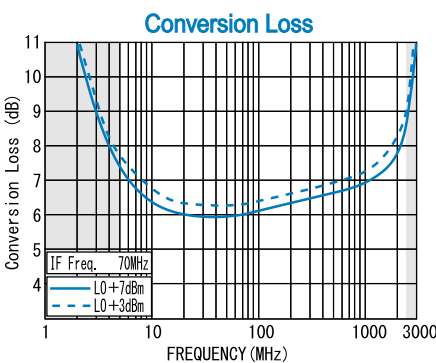

SCHEMATIC

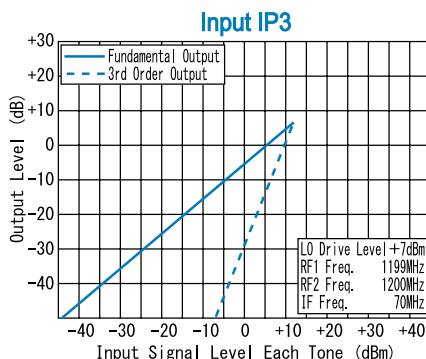
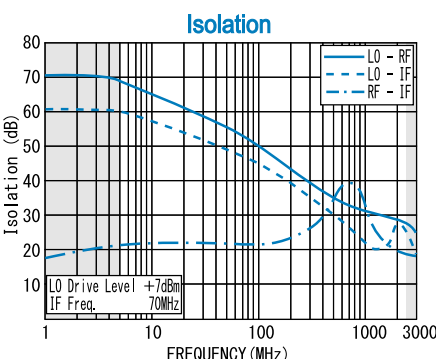
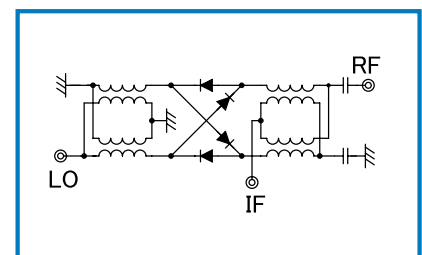

R&K reserves the right to make changes in the specifications of or discontinue products at any time without notice. R&K products shall not be used for or in connection with equipment that requires an extremely high level of reliability and safety such as aerospace uses or medical life support equipment. Further, R&K cannot export products to any country for use in military or defense applications.

R&K Company Limited

721-1 Maeda, Fuji-City, Shizuoka-Pref. 416-8577 Japan
 Tel : +81-545-31-2600 E-mail : info@rkco.jp
 Fax : +81-545-31-1600 URL : http://rk-microwave.com