

DOUBLE BALANCED MIXER

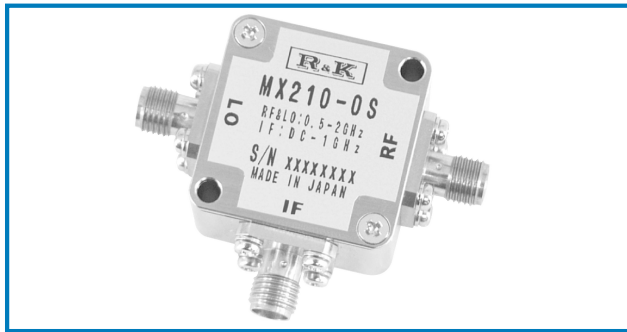

R&K-MX210-0S



OUTLINE DRAWING

※IN MILLIMETERS

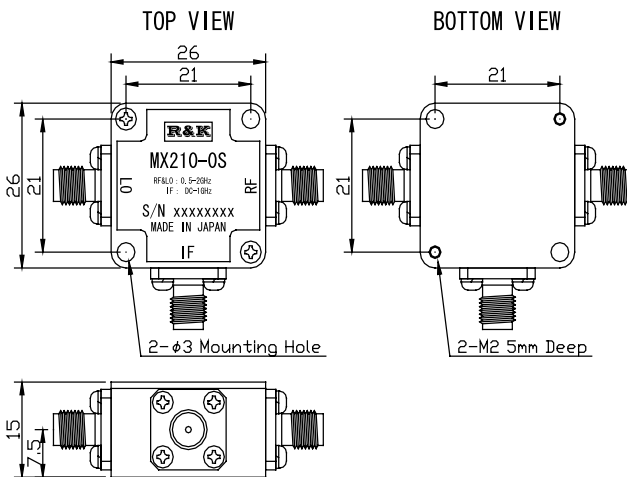

- LO&RF Frequency : 500 ~ 2000MHz
- IF Frequency : DC ~ 1000MHz
- Lo Drive Level : +7dBm
- Low Cost
- RoHS Compliance

SPECIFICATIONS

Frequency Range [LO&RF] : 500 - 2000MHz
 [IF] : DC - 1000MHz
 Conversion Loss Max. (LO Drive Level +7dBm)

	500 - 1000MHz	1000 - 1500MHz	1500 - 2000MHz
Typ.	6.5dB	6.0dB	8.0dB
Max.	10.0dB	8.0dB	11.0dB

Isolation (min.)

	500 - 1000MHz	1000 - 1500MHz	1500 - 2000MHz
LO - RF	20dB	20dB	20dB
LO - IF	20dB	20dB	15dB
RF - IF	15dB	10dB	8dB

- Input IP3 @Center Band : +9dBm (typ.)
- Input 1dB Comp. Point : +1dBm (typ.)
- Impedance (All Ports) : 50Ω
- Maximum RF Input Power : 50mW
- Maximum Peak IF Current : 50mA
- Operating Temperature : -40°C to +85°C
- Storage Temperature : -40°C to +100°C
- Connectors (Standard) : SMA-Female
- Connectors (Option) : N-Female
- Weight (SMA Connector) : 30g (typ.)

HOW TO ORDER

Model Name R&K-MX210-0S
 S = SMA - FEMALE
 N = N - FEMALE

TYPICAL PERFORMANCE (Temp @+25°C)

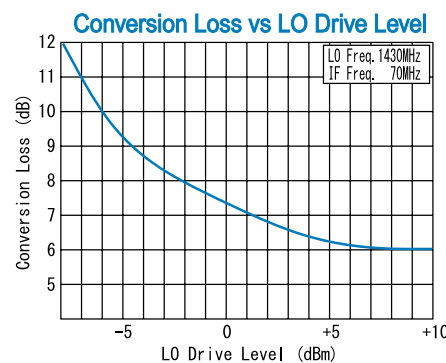
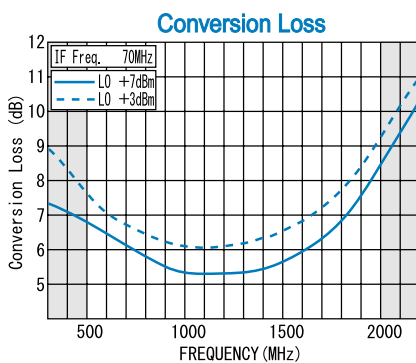

SCHEMATIC

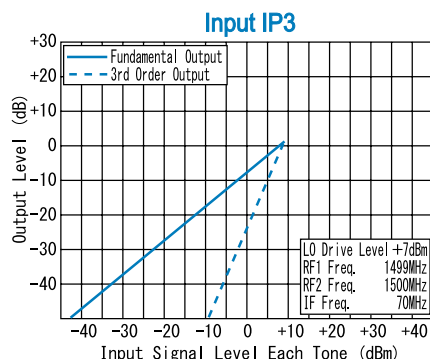
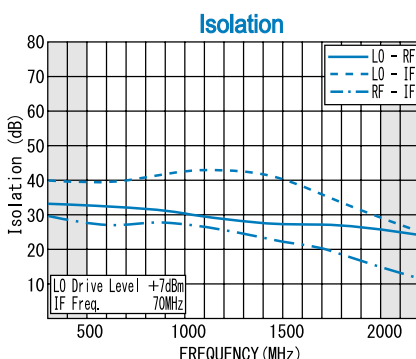
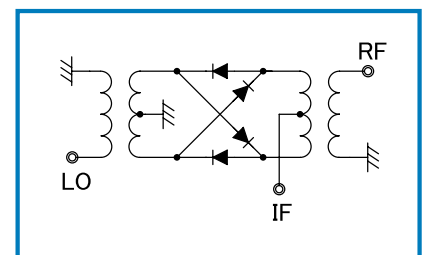

R&K reserves the right to make changes in the specifications of or discontinue products at any time without notice. R&K products shall not be used for or in connection with equipment that requires an extremely high level of reliability and safety such as aerospace uses or medical life support equipment. Further, R&K cannot export products to any country for use in military or defense applications.

R&K Company Limited

721-1 Maeda, Fuji-City, Shizuoka-Pref. 416-8577 Japan
 Tel: +81-545-31-2600 E-mail: info@rkco.jp
 Fax: +81-545-31-1600 URL: http://rk-microwave.com