

# DOUBLE BALANCED MIXER

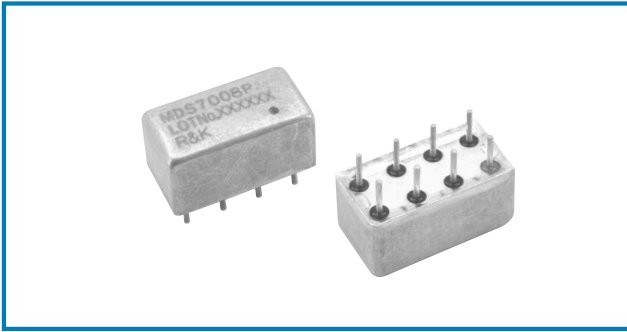

## R&K-MDS700



### OUTLINE DRAWING

※IN MILLIMETERS

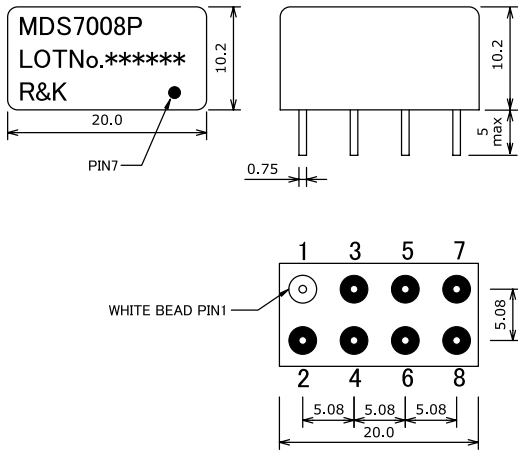

- Frequency : DC-500MHz
- S-High LO Drive Level : +25dBm
- Low Cost / 8PIN Package
- RoHS Compliance

### SPECIFICATIONS

Frequency Range [LO&RF] : 1-500MHz  
[IF] : DC-500MHz

Conversion Loss (LO Drive Level +25dBm)

	1 - 50MHz	50 - 200MHz	200 - 500MHz
Typ.	7.5dB	7.0dB	7.0dB
Max.	10.0dB	9.0dB	9.0dB

Isolation (min.)

	1 - 50MHz	50 - 200MHz	200 - 500MHz
LO - RF	45dB	35dB	30dB
LO - IF	40dB	30dB	25dB
RF - IF	25dB	20dB	20dB

Input IP3 @Center Band : +24dBm (typ.)  
Input 1dB Comp. Point : +15dBm (typ.)  
Impedance (All Ports) : 50Ω  
Maximum RF Input Power : 1000mW  
Maximum Peak IF Current : 50mA  
Operating Temperature : -40°C to +85°C  
Storage Temperature : -40°C to +100°C

### HOW TO ORDER

Model Name

R&K-MDS7008P 8P=8PIN Package

### TYPICAL PERFORMANCE (Temp @+25°C)

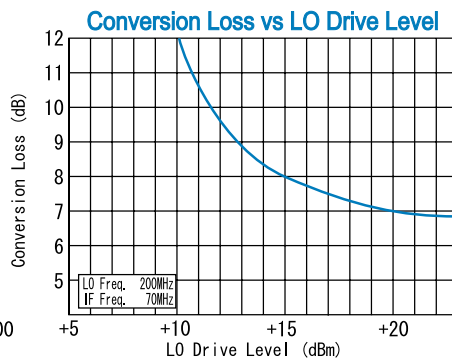
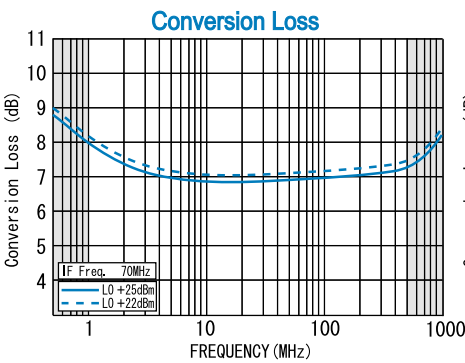

### SCHEMATIC

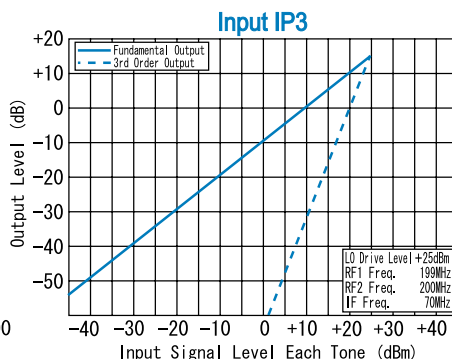
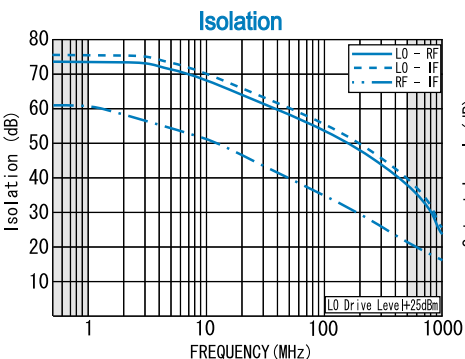
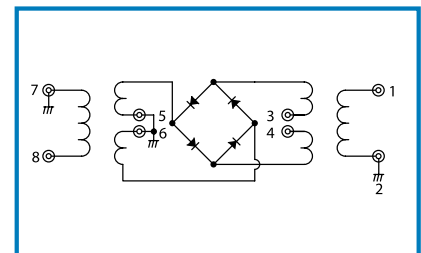

Function	Pin No.
RF	1
IF	3, 4
LO	8
GND	2, 5, 6, 7

R&K reserves the right to make changes in the specifications of or discontinue products at any time without notice. R&K products shall not be used for or in connection with equipment that requires an extremely high level of reliability and safety such as aerospace uses or medical life support equipment. Further, R&K cannot export products to any country for use in military or defense applications.

## R&K Company Limited

721-1 Maeda, Fuji-City, Shizuoka-Pref. 416-8577 Japan  
Tel: +81-545-31-2600 E-mail: info@rkco.jp  
Fax: +81-545-31-1600 URL: http://rk-microwave.com