

# DOUBLE BALANCED MIXER

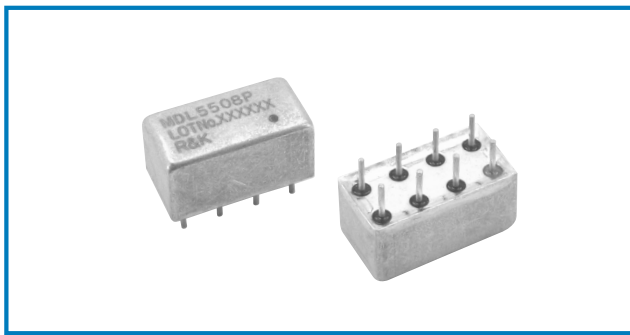

## R&K-MDL550



### OUTLINE DRAWING

※ IN MILLIMETERS

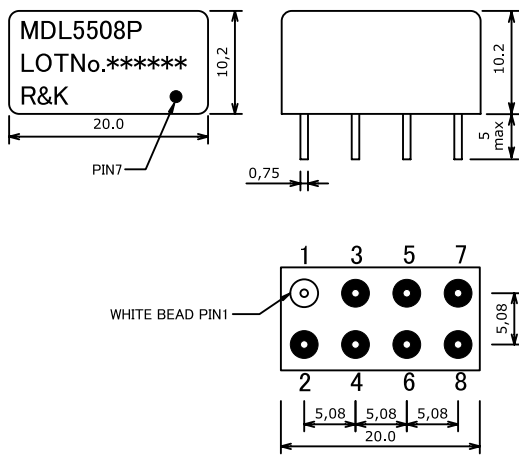

- Frequency : DC-2000MHz
- Low LO Drive Level : +7dBm
- Low Cost / 8PIN Package
- RoHS Compliance

### SPECIFICATIONS

Frequency Range [LO&RF] : 1-2000MHz  
[IF] : DC-1000MHz  
Conversion Loss (LO Drive Level +7dBm)

	1 - 100MHz	100 - 1000MHz	1000 - 2000MHz
Typ.	6.0dB	6.0dB	8.0dB
Max.	8.0dB	8.0dB	10.0dB

### Isolation (min.)

	1 - 100MHz	100 - 1000MHz	1000 - 2000MHz
LO - RF	20dB	25dB	25dB
LO - IF	25dB	20dB	20dB
RF - IF	25dB	20dB	15dB

Input IP3 @Center Band : +14dBm (typ.)  
Input 1dB Comp. Point : +7dBm (typ.)  
Impedance (All Ports) : 50Ω  
Maximum RF Input Power : 100mW  
Maximum Peak IF Current : 50mA  
Operating Temperature : -40°C to +85°C  
Storage Temperature : -40°C to +100°C

### HOW TO ORDER

Model Name  
R&K-MDL5508P

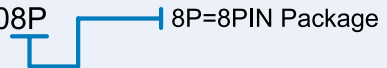

### TYPICAL PERFORMANCE (Temp @+25°C)

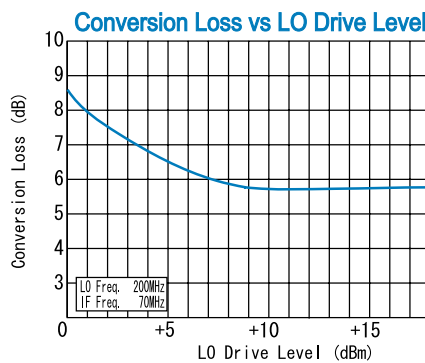
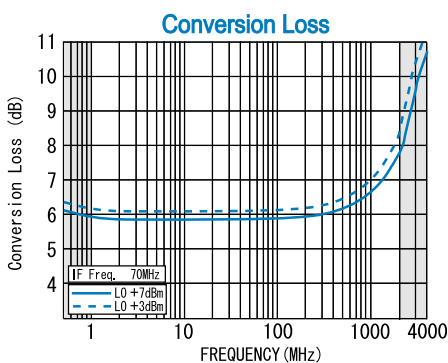

### SCHEMATIC

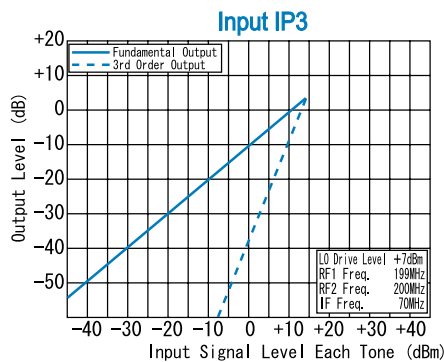
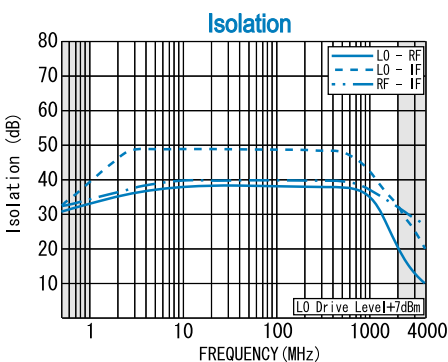
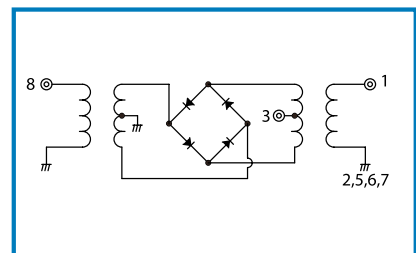

Function	Pin No.
RF	1
IF	3
LO	8
GND	2, 5, 6, 7
N.C.	4

R&K reserves the right to make changes in the specifications of or discontinue products at any time without notice. R&K products shall not be used for or in connection with equipment that requires an extremely high level of reliability and safety such as aerospace uses or medical life support equipment. Further, R&K cannot export products to any country for use in military or defense applications.

## R&K Company Limited

721-1 Maeda, Fuji-City, Shizuoka-Pref. 416-8577 Japan  
Tel : +81-545-31-2600 E-mail : info@rk.co.jp  
Fax : +81-545-31-1600 URL : http://rk-microwave.com