

DOUBLE BALANCED MIXER

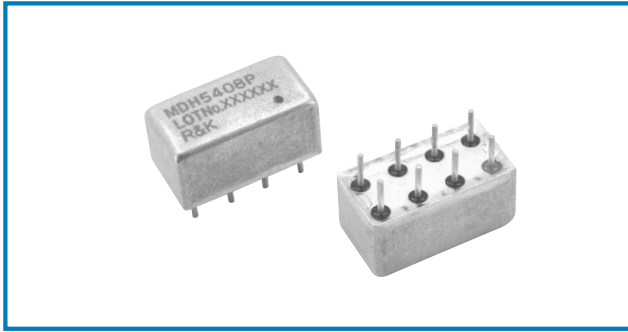

R&K-MDH540



OUTLINE DRAWING

※ IN MILLIMETERS

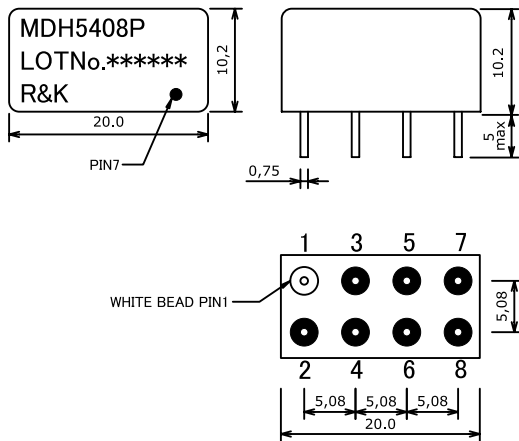

- Frequency : DC-3000MHz
- High LO Drive Level : +17dBm
- Low Cost / 8PIN Package
- RoHS Compliance

SPECIFICATIONS

Frequency Range [LO&RF] : 0.1-3000MHz
[IF] : DC-1000MHz

Conversion Loss (LO Drive Level +17dBm)

	0.1 - 100MHz	100 - 1000MHz	1000 - 3000MHz
Typ.	6.0dB	5.5dB	9.0dB
Max.	8.5dB	7.5dB	11.0dB

Isolation (min.)

	0.1 - 100MHz	100 - 1000MHz	1000 - 2000MHz
LO - RF	15dB	25dB	20dB
LO - IF	20dB	25dB	15dB
RF - IF	20dB	20dB	10dB

- Input IP3 @Center Band : +20dBm (typ.)
- Input 1dB Comp. Point : + 9dBm (typ.)
- Impedance (All Ports) : 50Ω
- Maximum RF Input Power : 200mW
- Maximum Peak IF Current : 100mA
- Operating Temperature : -40°C to + 85°C
- Storage Temperature : -40°C to +100°C

HOW TO ORDER

Model Name
R&K-MDH5408P 8P=8PIN Package

TYPICAL PERFORMANCE (Temp @+25°C)

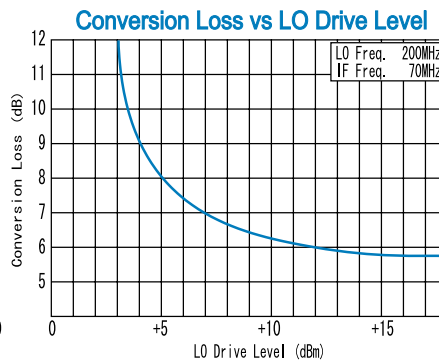
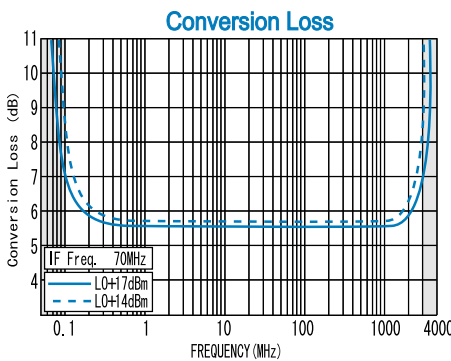

SCHEMATIC

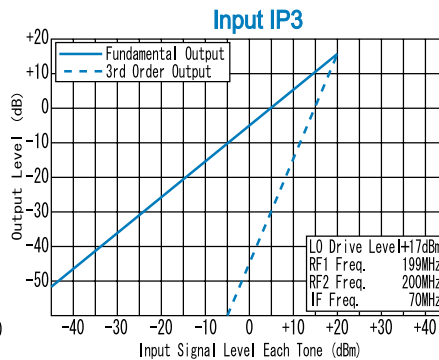
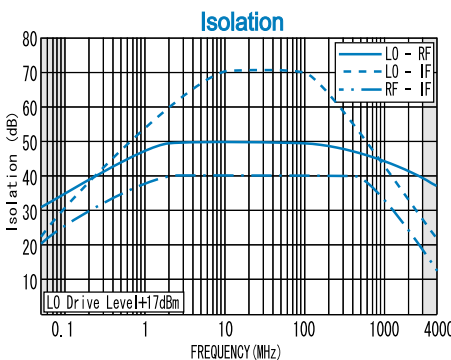
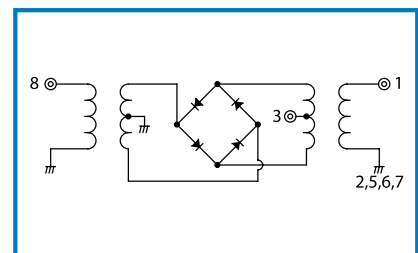

Function	Pin No.
RF	1
IF	3
LO	8
GND	2, 5, 6, 7
NO CONNECTION	4

R&K reserves the right to make changes in the specifications of or discontinue products at any time without notice. R&K products shall not be used for or in connection with equipment that requires an extremely high level of reliability and safety such as aerospace uses or medical life support equipment. Further, R&K cannot export products to any country for use in military or defense applications.

R&K Company Limited

721-1 Maeda, Fuji-City, Shizuoka-Pref. 416-8577 Japan
Tel: +81-545-31-2600 E-mail: info@rk.co.jp
Fax: +81-545-31-1600 URL: http://rk-microwave.com