

## R&K-LP5CH3-0S

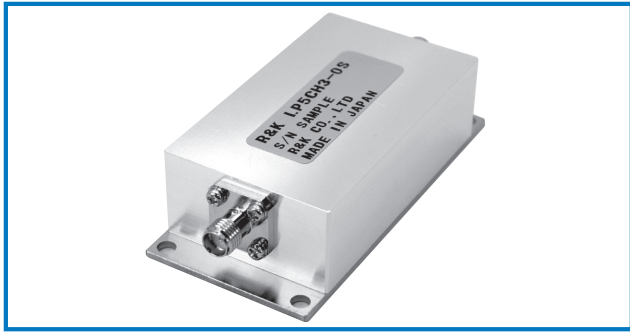

### OUTLINE DRAWING

※IN MILLIMETERS

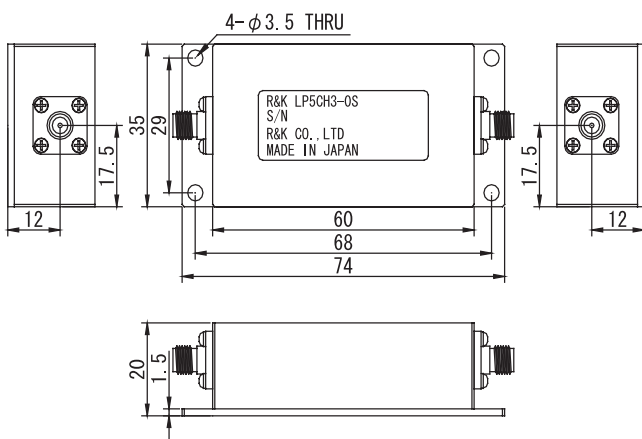

- Passband Frequency : DC ~ 5MHz
- Insertion Loss : 1.0dB (max.)
- VSWR : 1.3 (typ.)
- Chebyshev
- RoHS Compliance

### SPECIFICATIONS

Passband Frequency	: DC - 5MHz
Insertion Loss	: 1.0dB (max.)
Rejection (10MHz to 25MHz)	: 45dB (typ.)
Passband Ripple	: 1.0dB (max.)
Impedance	: 50 Ω
VSWR	: 1.3:1 (typ.)
Delay	: 400ns (max.)
Maximum RF Input Power	: +33dBm
Operating Temperature	: -20°C to +60°C
Storage Temperature	: -20°C to +80°C
Connectors (Standard)	: SMA-FEMALE
Connectors (Option)	: BNC-FEMALE : N-FEMALE
Weight (SMA Connector)	: 90g (typ.)

### HOW TO ORDER

Model Name R&K-LP5CH3-0S

S	= SMA - FEMALE
B	= BNC - FEMALE
N	= N - FEMALE

### TYPICAL PERFORMANCE (Temp @+25°C)

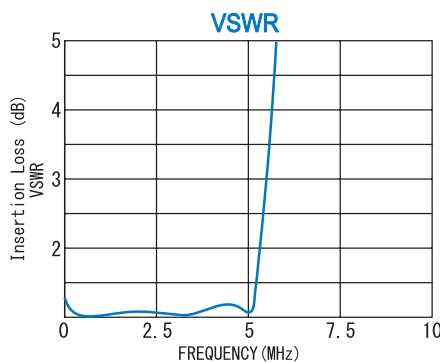
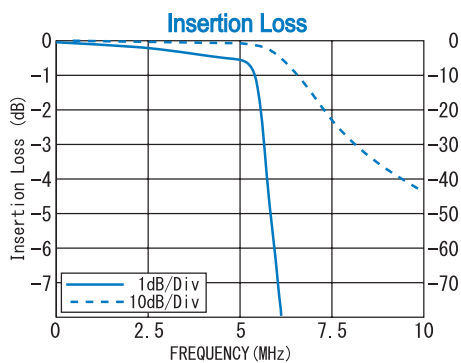

### SCHEMATIC

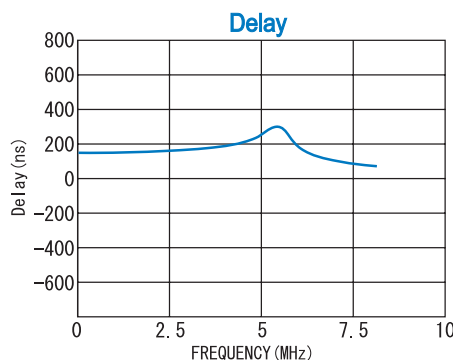
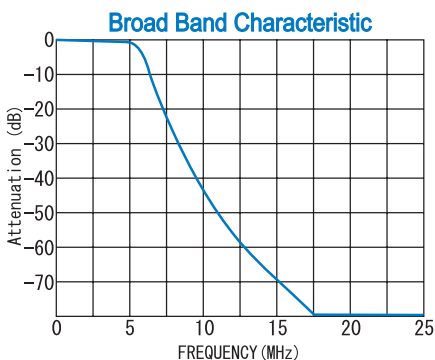
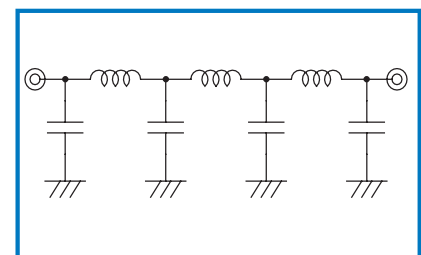

R&K reserves the right to make changes in the specifications of or discontinue products at any time without notice. R&K products shall not be used for or in connection with equipment that requires an extremely high level of reliability and safety such as aerospace uses or medical life support equipment. Further, The export of R&K products from Japan may be subject to an export license by the government of Japan, based on Japan's "Foreign Exchange and Foreign Trade Law".

## R&K Company Limited

721-1 Maeda, Fuji-City, Shizuoka-Pref. 416-8577 Japan  
 Tel : +81-545-31-2600 E-mail : info@rkco.jp  
 Fax : +81-545-31-1600 URL : http://rk-microwave.com