

# LOW NOISE AMPLIFIER

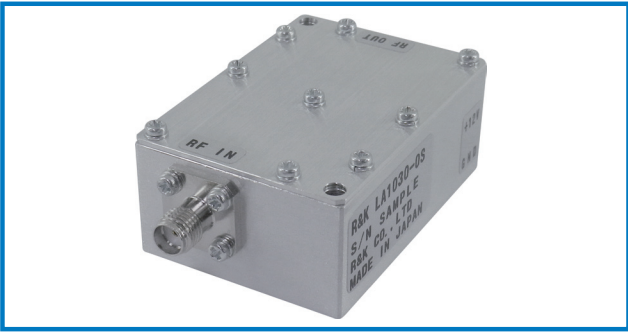

## R&K-LA1030-0S



### OUTLINE DRAWING

※IN MILLIMETERS

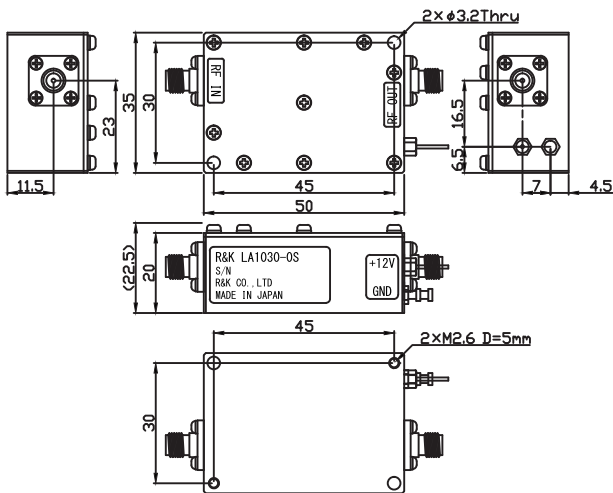

- Broadband Frequency : 600MHz ~ 4200MHz
- Noise Figure : 1.2dB (typ.) / 2dB (max.)
- Output Power : +20dBm @2GHz
- Small Signal Gain : +20dB (typ.) @2GHz
- Low Cost
- RoHS Compliance

### SPECIFICATIONS

- Frequency Range : 600MHz ~ 4200MHz
- Noise Figure @ +25°C : 1.2dB (typ.)
- 20°C to +60°C : 2.0dB (max.)
- Small Signal Gain : +20dB (typ.) @2GHz
- +18dB (min.)
- Gain Flatness : ±1.5dB (max.)
- Output Power @ 1dB Comp. : +20dBm (min.) @2GHz
- Output I.C.P. : +35dBm (typ.) @2GHz
- Impedance : 50Ω
- Input Return Loss : 8dB (typ.)
- Output Return Loss : 10dB (typ.)
- DC Supply Input : +12V ±0.5V
- 150mA (max.)
- Maximum RF Input Power : +10dBm
- Operating Temperature : -20°C to +60°C
- Storage Temperature : -20°C to +80°C
- Connectors : SMA-FEMALE
- Weight : 85g (typ.)

### HOW TO ORDER

Model Name  
R&K-LA1030-0S

No Option

### TYPICAL PERFORMANCE (Temp @+25°C)

#### Small Signal Gain & Gain Flatness Input & Output Return Loss

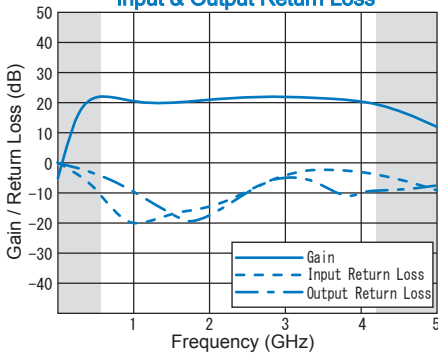

#### Noise Figure

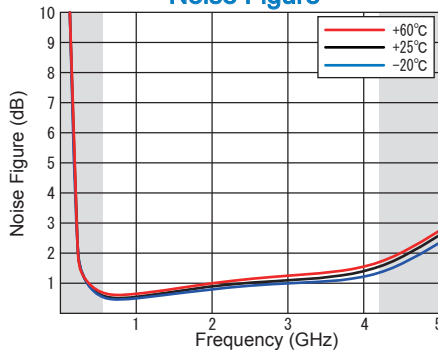

#### SCHEMATIC

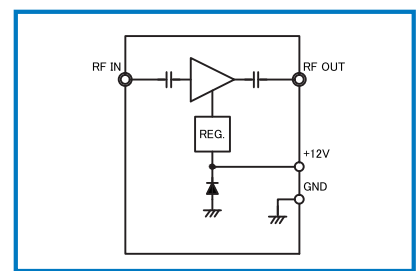

#### Output Power 1dB & Power Saturation Output 3rd Order Intercept Point

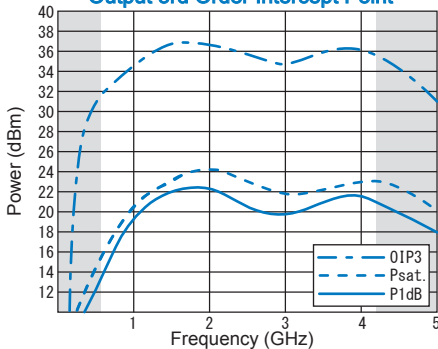

#### Pulse Characteristics

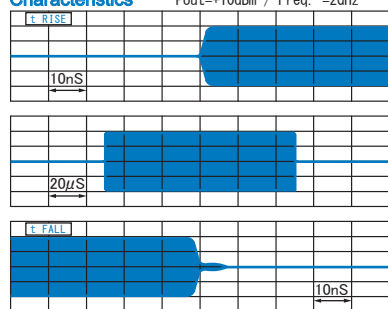

#### Input vs Output Linearity

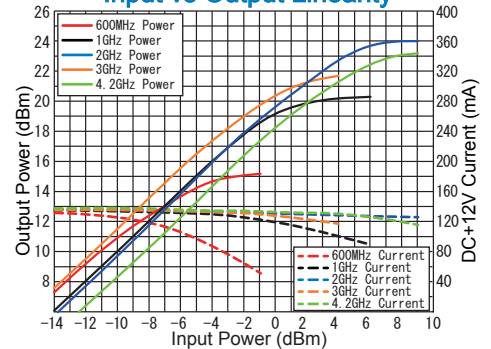

R&K reserves the right to make changes in the specifications of or discontinue products at any time without notice. R&K products shall not be used for or in connection with equipment that requires an extremely high level of reliability and safety such as aerospace uses or medical life support equipment. Further, The export of R&K products from Japan may be subject to an export license by the government of Japan, based on Japan's "Foreign Exchange and Foreign Trade Law".

## R&K Company Limited

721-1 Maeda, Fuji-City, Shizuoka-Pref. 416-8577 Japan  
Tel: +81-545-31-2600 E-mail: info@rkco.jp  
Fax: +81-545-31-1600 URL: http://rk-microwave.com