

## R&K-HYB510

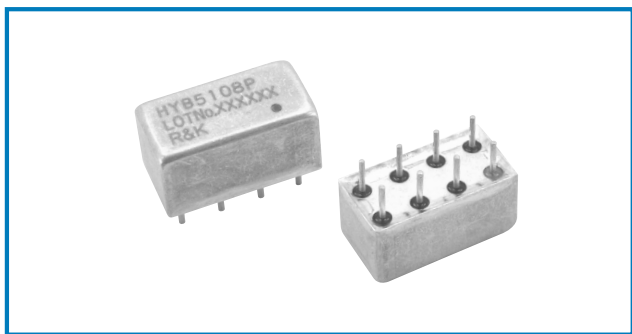

### OUTLINE DRAWING

※IN MILLIMETERS

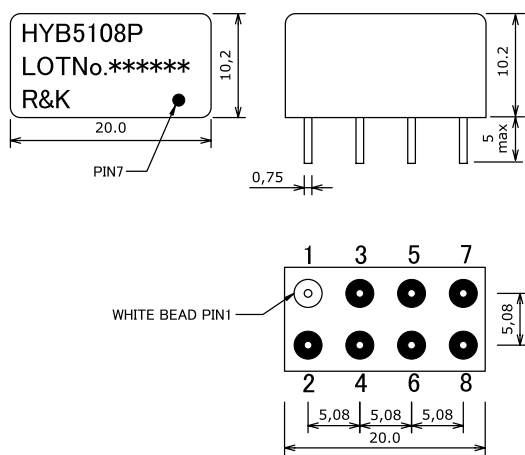

- Frequency : 1-500MHz
- 2WAY-180°
- Low Cost / 8PIN Package
- RoHS Compliance

### SPECIFICATIONS

Frequency Range	: 1-500MHz
Insertion Loss	: 2.5dB (max.)(1MHz-400MHz) (Except Theoretical Loss -3dB): 3.5dB (max.)(400MHz-500MHz)
Isolation	: 18dB (min.)
Amplitude Balance	: 0.9dB (max.)
Phase Balance	: ±5.0deg (max.)
VSWR	: 1.3:1(typ.)
Impedance (ALL Ports)	: 50 Ω
Maximum RF Input Power	: 1W (max.)
Internal Load Dissipation	: 0.1W
Operating Temperature	: -40°C to + 85°C
Storage Temperature	: -40°C to +100°C

### HOW TO ORDER

Model Name  
R&K-HYB5108P 8P=8PIN Package

### TYPICAL PERFORMANCE (Temp @+25°C)

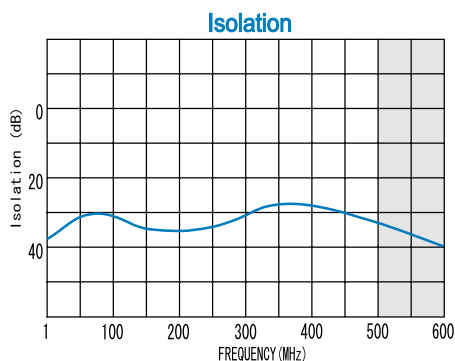
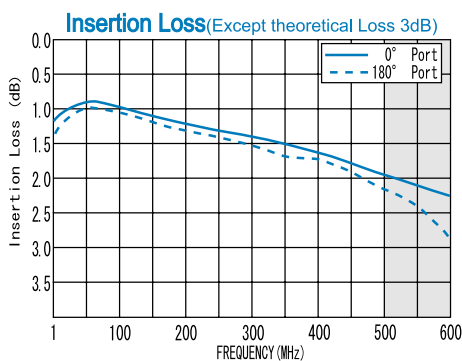

### SCHEMATIC

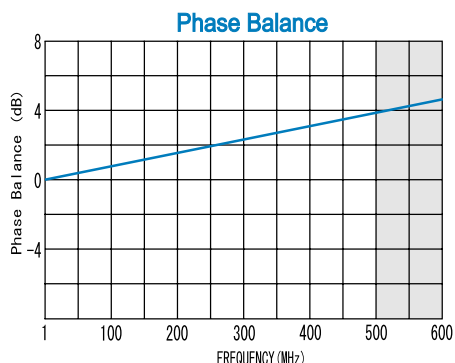
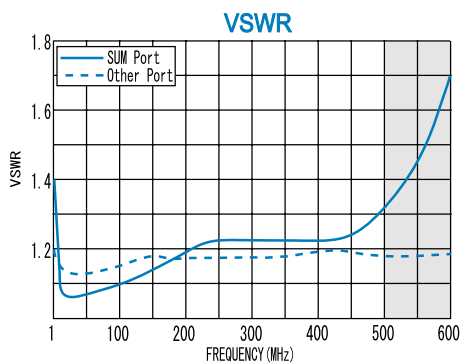
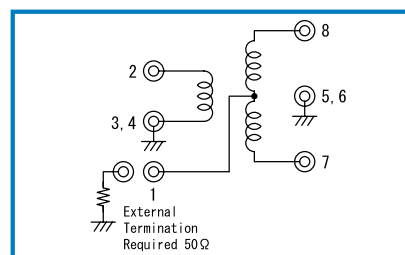

Function	Pin No.
SUM	2
180°	7
0°	8
ISO.	1
GND	3, 4, 5, 6

R&K reserves the right to make changes in the specifications of or discontinue products at any time without notice. R&K products shall not be used for or in connection with equipment that requires an extremely high level of reliability and safety such as aerospace uses or medical life support equipment. Further, R&K cannot export products to any country for use in military or defense applications.

## R&K Company Limited

721-1 Maeda, Fuji-City, Shizuoka-Pref. 416-8577 Japan  
Tel : +81-545-31-2600 E-mail : info@rk.co.jp  
Fax : +81-545-31-1600 URL : http://rk-microwave.com