

R&K-ALM1015-2840FR-R

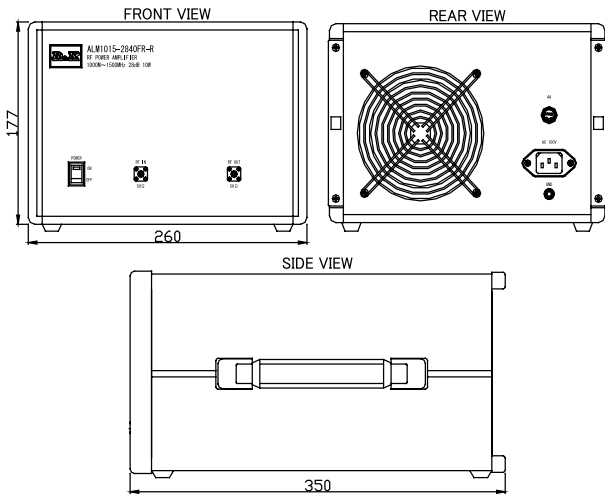

OUTLINE DRAWING

※ IN MILLIMETERS



- Broadband Frequency : 1000 ~ 1500MHz
- Output Power : +40dBm
- Gain Flatness : ±1.0dB (max.)
- Low Cost
- RoHS Compliance

SPECIFICATIONS

Frequency Range	: 1000 - 1500MHz
Small Signal Gain	: +30dB (typ.) : +28dB (min.)
Gain Flatness	: ±1.0dB (max.)
Output Power@1dB Comp.	: +40dBm (min.)
Output I.C.P.	: +52dBm (typ.) @1250MHz
Noise Figure	: 12dB (max.)
Impedance	: 50 Ω
Input VSWR	: 1.3 : 1 (typ.)
Output VSWR	: 1.5 : 1 (typ.)
Harmonics	: -18dBc (max.) @+40dBm Output
Spurious	: -60dBc (max.) @+40dBm Output
AC Supply Input	: AC100V : 50/60Hz 2A (max.)
Maximum RF Input Power	: +17dBm
Operating Temperature	: -10°C to +45°C
Storage Temperature	: -15°C to +65°C
Connectors	: SMA-FEMALE
Weight	: 9kg (typ.)

HOW TO ORDER

Model Name
R&K-ALM1015-2840FR-R No Option

TYPICAL PERFORMANCE (Temp @+25°C)

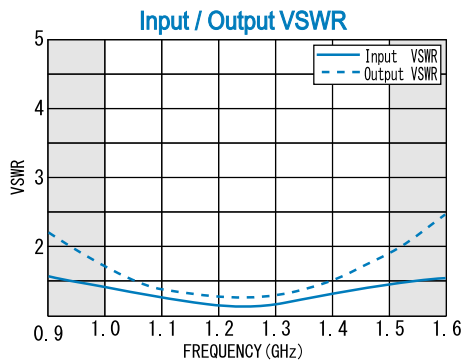
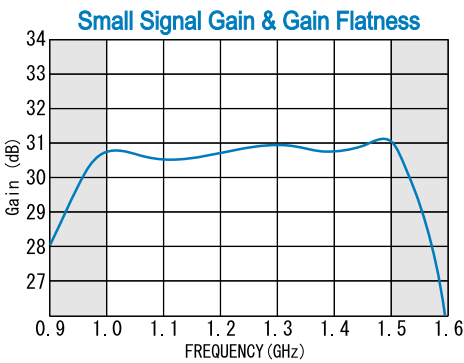

SCHEMATIC

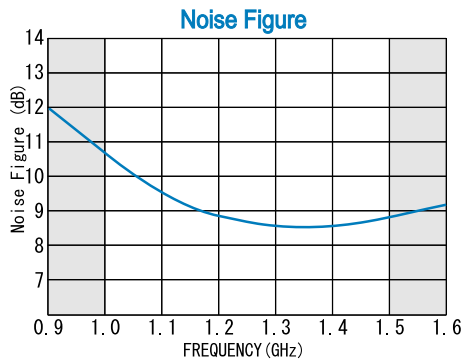
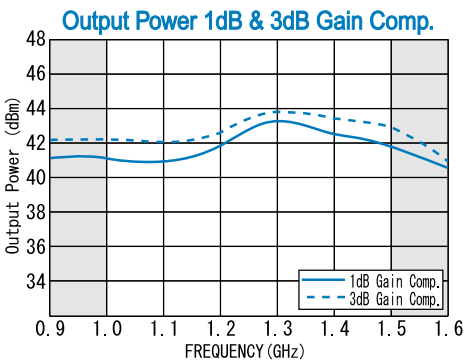
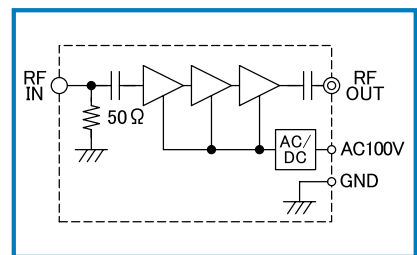

R&K reserves the right to make changes in the specifications of or discontinue products at any time without notice. R&K products shall not be used for or in connection with equipment that requires an extremely high level of reliability and safety such as aerospace uses or medical life support equipment. Further, R&K cannot export products to any country for use in military or defense applications.

R&K Company Limited

721-1 Maeda, Fuji-City, Shizuoka-Pref. 416-8577 Japan
Tel : +81-545-31-2600 E-mail : info@rkco.jp
Fax : +81-545-31-1600 URL : http://rk-microwave.com