

## R&K-ALM0510-3846-SMA

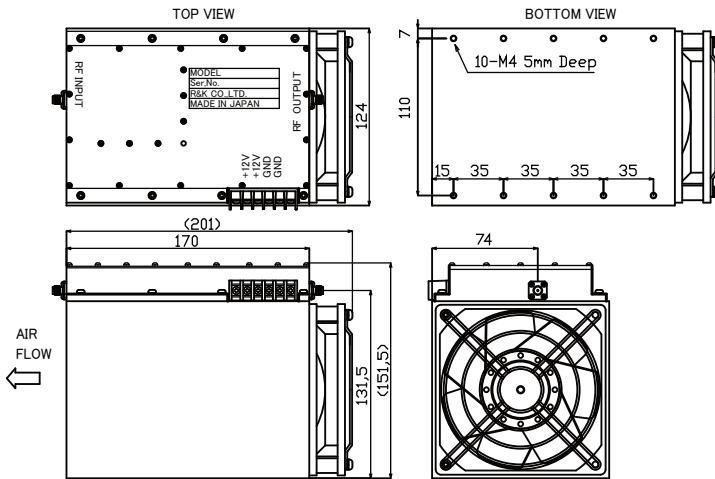

### OUTLINE DRAWING

※ IN MILLIMETERS



- Broadband Frequency: 500 ~ 1000MHz
- Output Power : +44dBm
- Gain Flatness : ±2.0dB (typ.)
- Without Output circulator
- **Low Cost** : @¥198,000

### SPECIFICATIONS

Frequency Range	: 500~1000MHz
Small Signal Gain	: +38dB (typ.)
	: +37dB (min.)
Gain Flatness	: ±2.0dB (typ.)
Output Power@3dB Comp.	: +44dBm (min.)
Output I.C.P.	: +56dBm (typ.) @750MHz
Noise Figure	: 6dB (max.)
Impedance	: 50 Ω
Input VSWR	: 3.0 : 1 (typ.)
Output VSWR	: 3.0 : 1 (typ.)
DC Supply Input	: +12V ±0.5V
	: 14A (max.)
Maximum RF Input Power	: +12dBm
Operating Temperature	: -10°C to +45°C
Storage Temperature	: -15°C to +65°C
Connectors	: SMA-FEMALE
Weight	: 3kg (typ.)

**Forced Air Cooling Required**

### HOW TO ORDER

Model Name  
R&K-ALM0510-3846-SMA No Option

### TYPICAL PERFORMANCE (Temp @+25°C)

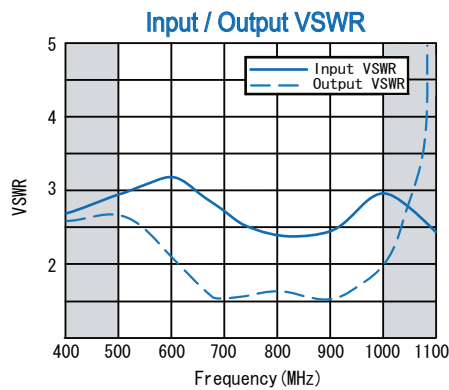
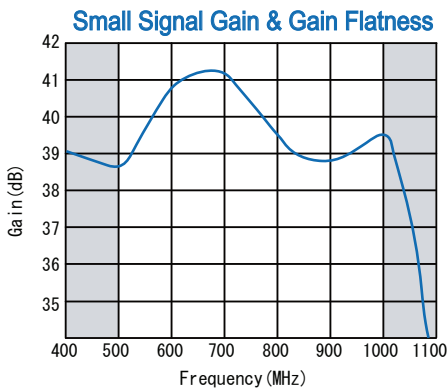

### SCHEMATIC

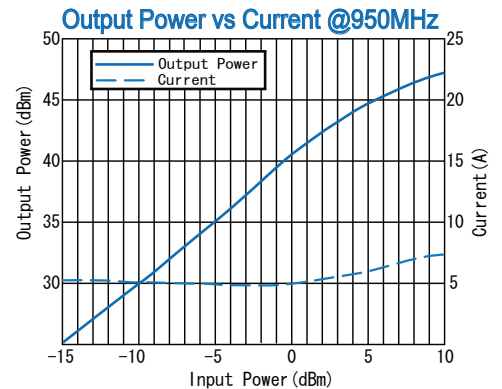
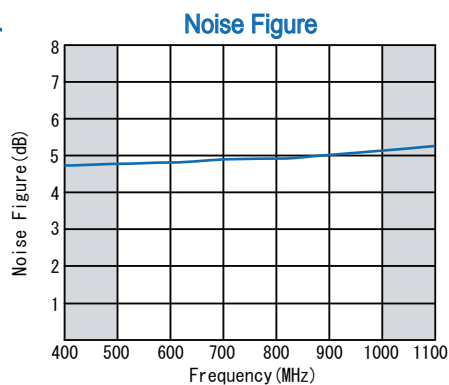
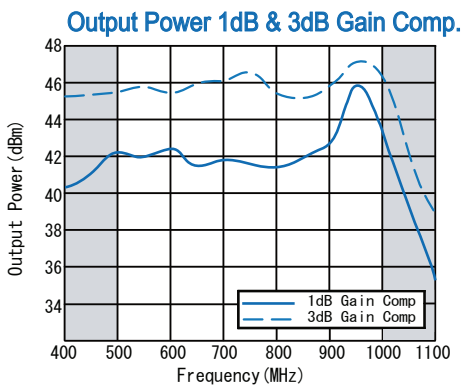
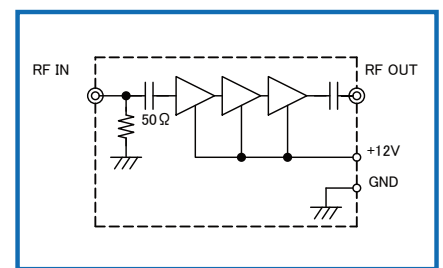

R&K reserves the right to make changes in the specifications of or discontinue products at any time without notice. R&K products shall not be used for or in connection with equipment that requires an extremely high level of reliability and safety such as aerospace uses or medical life support equipment. Further, R&K cannot export products to any country for use in military or defense applications.

## R&K Company Limited

721-1 Maeda, Fuji-City, Shizuoka-Pref. 416-8577 Japan  
Tel : +81-545-31-2600 E-mail : info@rkco.jp  
Fax : +81-545-31-1600 URL : http://rk-microwave.com