

R&K-ALM0105-4748-SMA

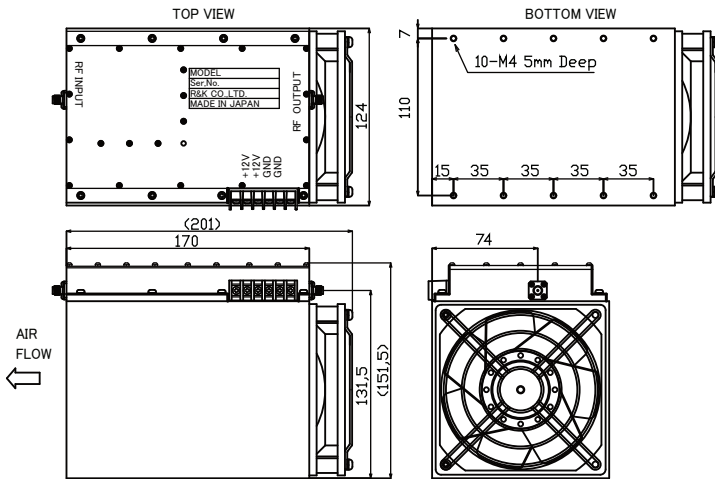

OUTLINE DRAWING

※ IN MILLIMETERS



TYPICAL PERFORMANCE (Temp @+25°C)

Small Signal Gain & Gain Flatness

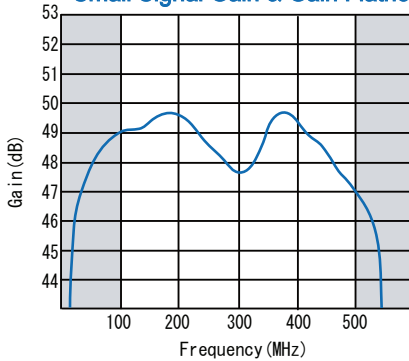

Input / Output VSWR

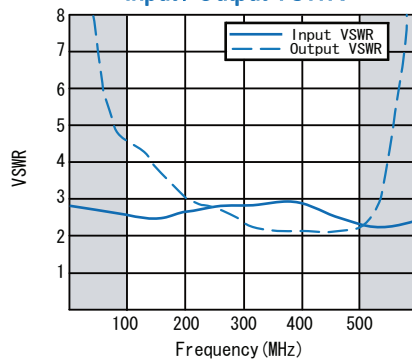

Output Power 1dB & 3dB Gain Comp.

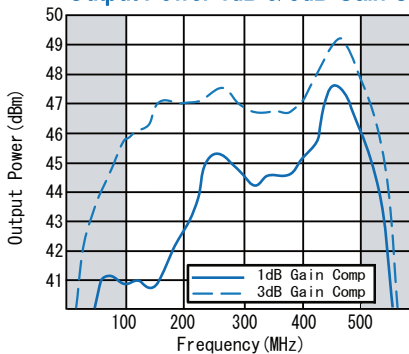

Noise Figure

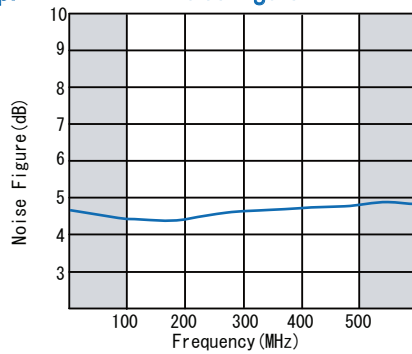

SCHEMATIC

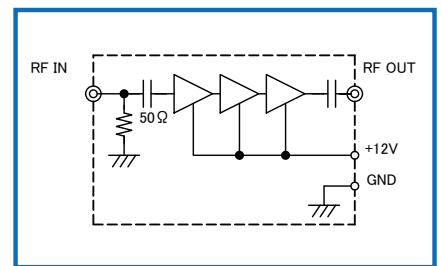

Output Power vs Current @500MHz

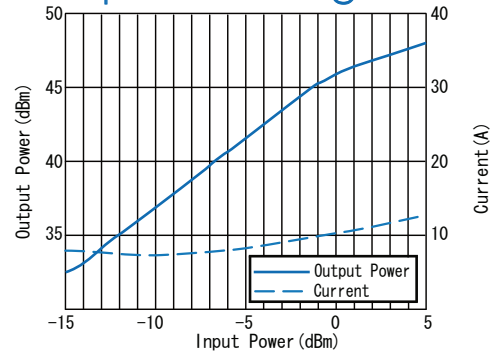

- Broadband Frequency : 100 ~ 500MHz
- Output Power : +48dBm
- Gain Flatness : ±2.5dB (typ.)
- Without Output circulator
- **Low Cost** : @¥198,000

SPECIFICATIONS

Frequency Range	: 100~500MHz
Small Signal Gain	: +48dB (typ.) : +46dB (min.)
Gain Flatness	: ±2.5dB (typ.)
Output Power@3dB Comp.	: +45dBm (min.)
Output I.C.P.	: +55dBm (typ.) @500MHz
Noise Figure	: 6.5dB (max.)
Impedance	: 50Ω
Input VSWR	: 3.0 : 1 (typ.)
Output VSWR	: 5.0 : 1 (typ.)
DC Supply Input	: +12V ±0.5V : 16A (max.)
Maximum RF Input Power	: +5dBm
Operating Temperature	: -10°C to +45°C
Storage Temperature	: -15°C to +65°C
Connectors	: SMA-FEMALE
Weight	: 3kg (typ.)

Forced Air Cooling Required

HOW TO ORDER

Model Name
R&K-ALM0105-4748-SMA No Option

R&K reserves the right to make changes in the specifications of or discontinue products at any time without notice. R&K products shall not be used for or in connection with equipment that requires an extremely high level of reliability and safety such as aerospace uses or medical life support equipment. Further, R&K cannot export products to any country for use in military or defense applications.

R&K Company Limited

721-1 Maeda, Fuji-City, Shizuoka-Pref. 416-8577 Japan
Tel : +81-545-31-2600 E-mail : info@rkco.jp
Fax : +81-545-31-1600 URL : http://rk-microwave.com