

# SMALL SIGNAL AMPLIFIER



## R&K-AA450-0S



### OUTLINE DRAWING

※IN MILLIMETERS

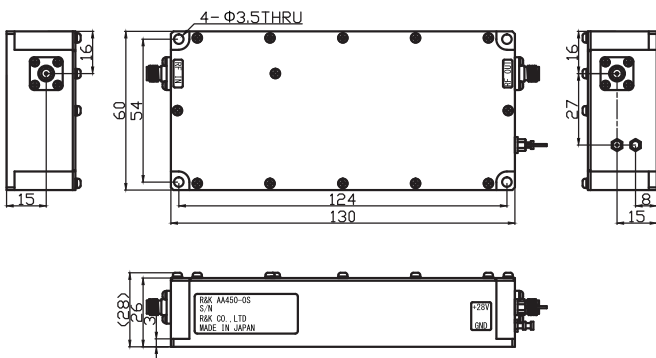

Base plate must be grounded and mounted to heat sink to guarantee operation up to maximum temperature.

- Broadband Frequency : 30MHz ~ 2700MHz
- Output Power : +39dBm (typ.) @P<sub>sat</sub>.
- Gain Flatness : ±2.0dB (max.)
- RoHS Compliance

### SPECIFICATIONS

Frequency Range	: 30MHz ~ 2700MHz
Small Signal Gain	: +35dB (typ.) @2GHz : +32dB (min.)
Gain Flatness	: ±2.0dB (max.)
Output Power@3dB Comp.	: +37dBm (min.) @2GHz
Output Power@P <sub>sat</sub> .	: +39dBm (typ.) @2GHz
Output I.C.P.	: +42dBm (typ.) @2GHz / P <sub>o</sub> =+29dBm(ave.)
Noise Figure	: 12.0dB (max.)
NOTE:N.F. value is only guaranteed in the range of 50MHz~2700MHz	
Impedance	: 50Ω
Input VSWR	: 1.8 : 1 (typ.)
Output VSWR	: 3.5 : 1 (typ.)
DC Supply Input	: +28V ±1V : 1.8A (max.)
Maximum RF Input Power	: +14dBm
Operating Temperature (@Base Plate Temp.)	: -20°C to +60°C
Storage Temperature	: -20°C to +80°C
Connectors (Standard)	: SMA-FEMALE
Connectors (Option)	: N-FEMALE
Weight (Standard)	: 370g (typ.)

### HOW TO ORDER

Model Name  
R&K-AA450-0S

S = SMA-FEMALE  
N = N-FEMALE

0 = Module  
1 = With Heatsink

### TYPICAL PERFORMANCE

#### Small Signal Gain & Gain Flatness

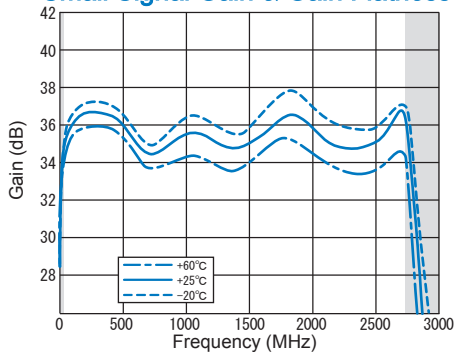

#### Input / Output VSWR

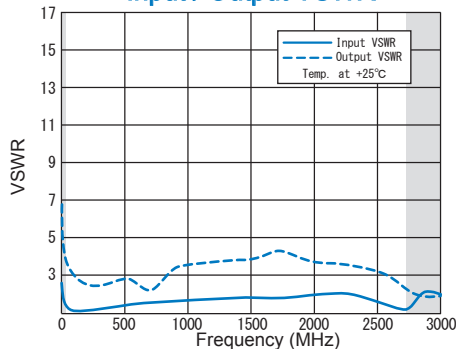

### SCHEMATIC

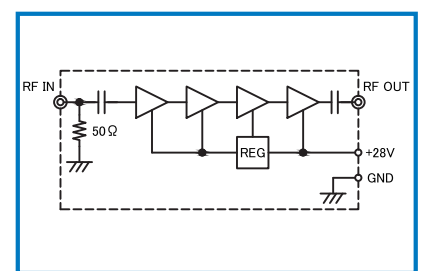

#### Output Power @3dB Gain Comp.

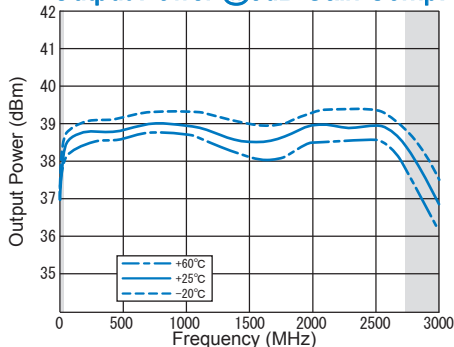

#### Output Power @P<sub>sat</sub>.

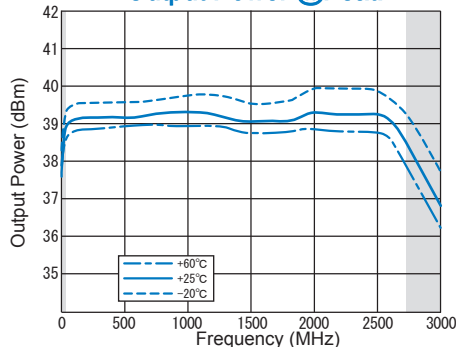

#### Noise Figure

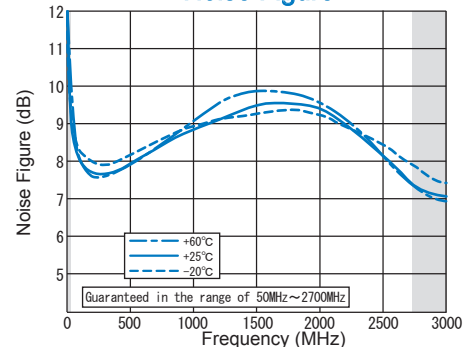

R&K reserves the right to make changes in the specifications of or discontinue products at any time without notice. R&K products shall not be used for or in connection with equipment that requires an extremely high level of reliability and safety such as aerospace uses or medical life support equipment. Further, R&K cannot export products to any country for use in military or defense applications.

## R&K Company Limited

721-1 Maeda, Fuji-City, Shizuoka-Pref. 416-8577 Japan  
Tel : +81-545-31-2600 E-mail : info@rkco.jp  
Fax : +81-545-31-1600 URL : http://rk-microwave.com